

Side C

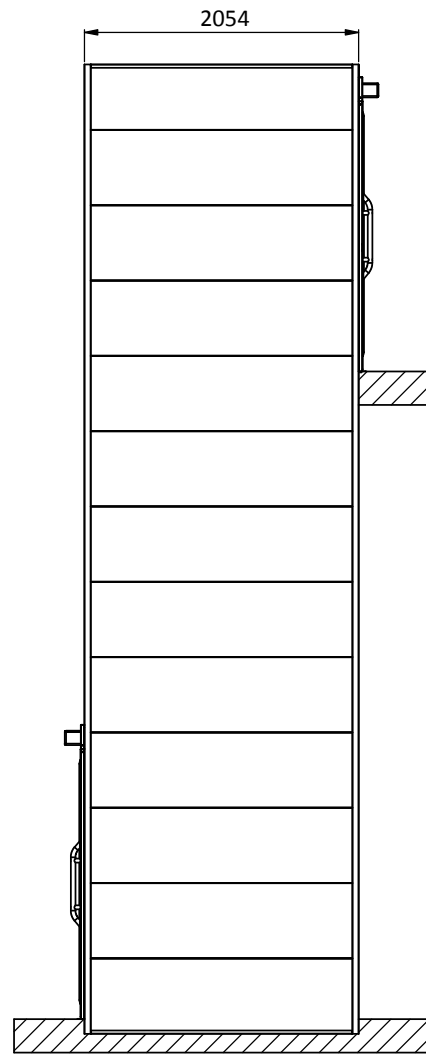

Side B

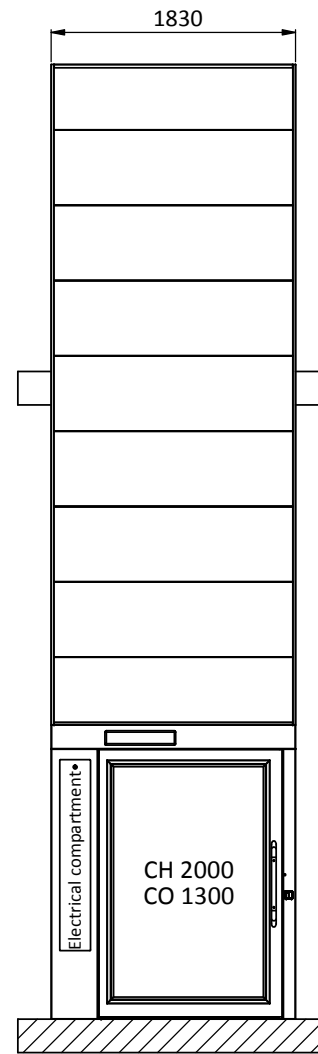

Side A

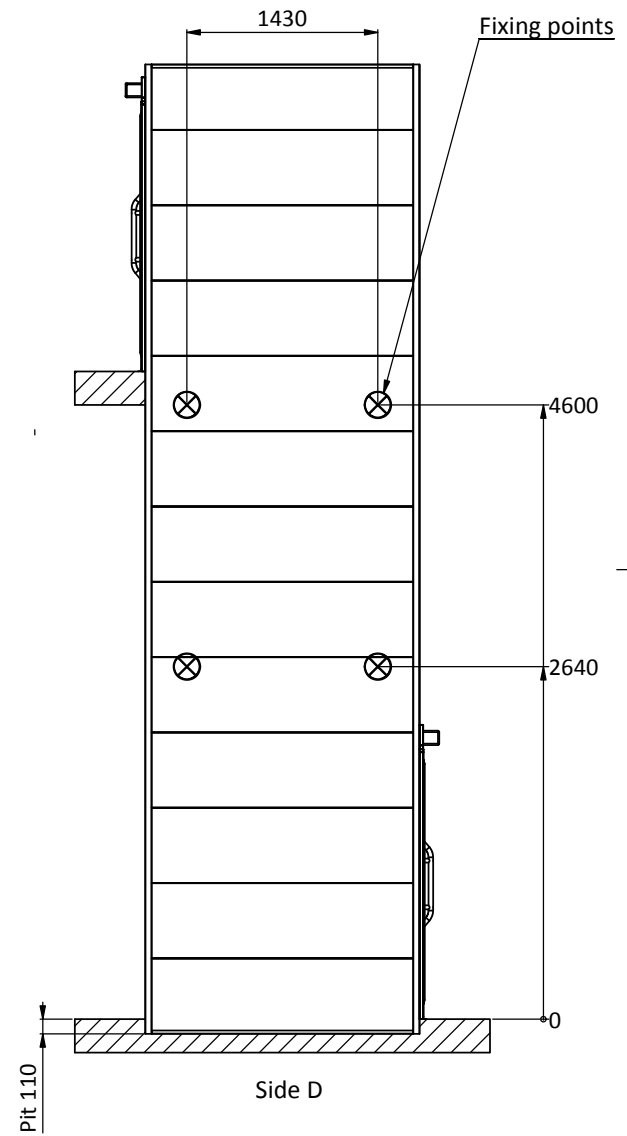

Side D

		Product	Drawn	Checked	Date	Customer
		ILS 1K	TS	JH	2015-02-05	
Title Principal drawing 1400x2000						
Innovation Lift Scandinavia AB Kranvägen 6 693 33 Degerfors						Docum ent Number Principal 12
						-00

Hook in the building ceiling
for 500 kg, by builder

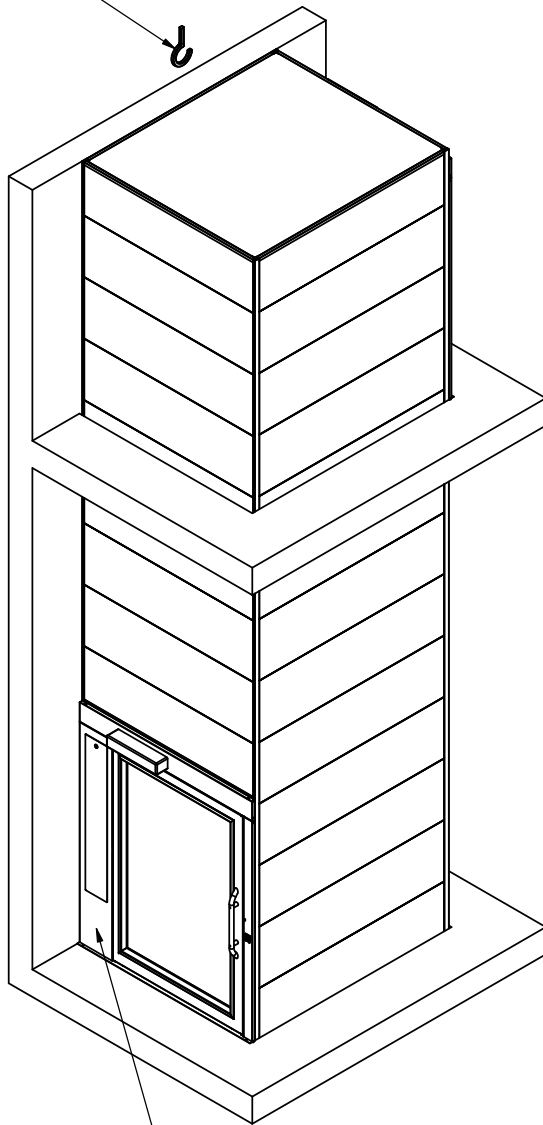

400 V, 3-phase, 16A slow,
Cable Area min 2,5 mm²

400 V, 3-phase, 16A slow,
Cable Area min 2,5 mm²

Overall dimensions

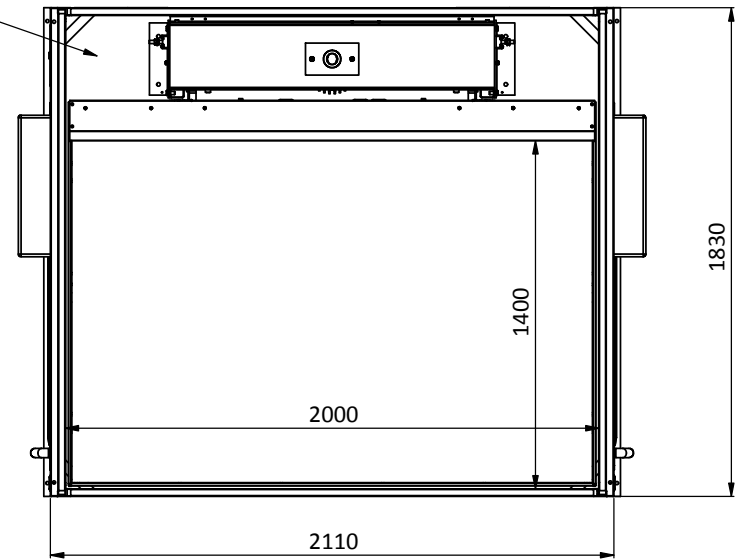

Cut out sizes

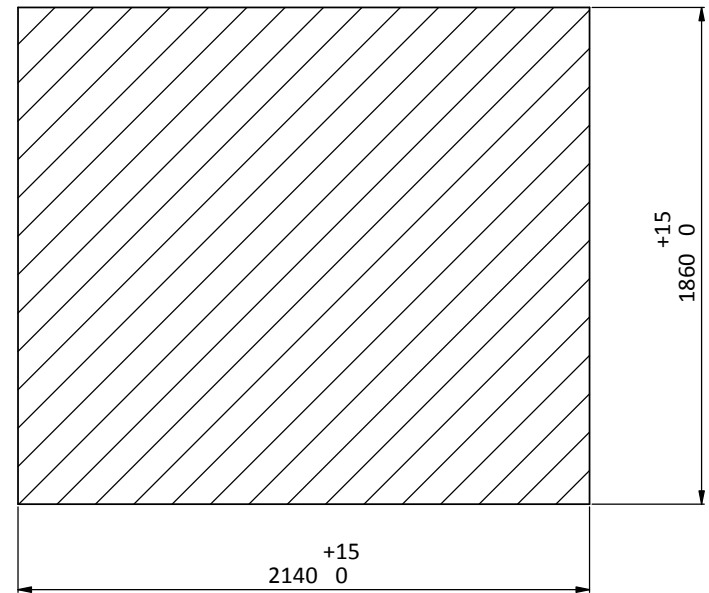

Innovation Lift
SCANDINAVIA AB

Product	Drawn	Checked	Date	Customer
ILS 1K	TS	JH	2015-02-05	
Title Principal drawing 1400x2000				
Innovation Lift Scandinavia AB Kranvägen 6 693 33 Degerfors				Document Number Principal 12
				-Revision -00