

Side C

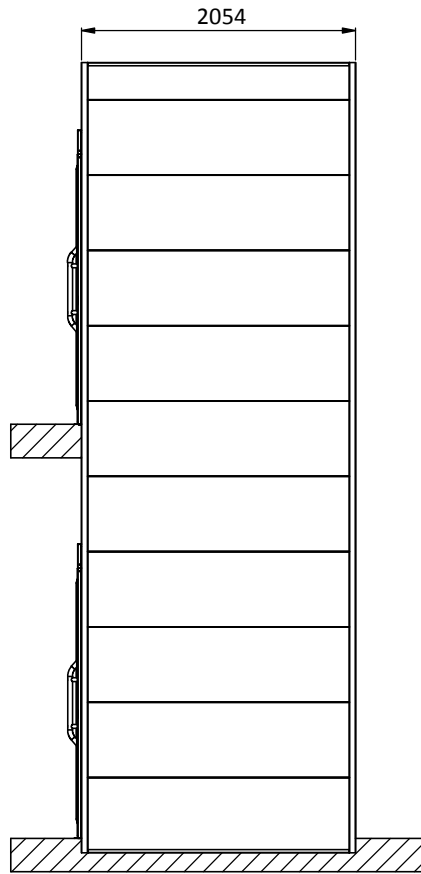

Side B

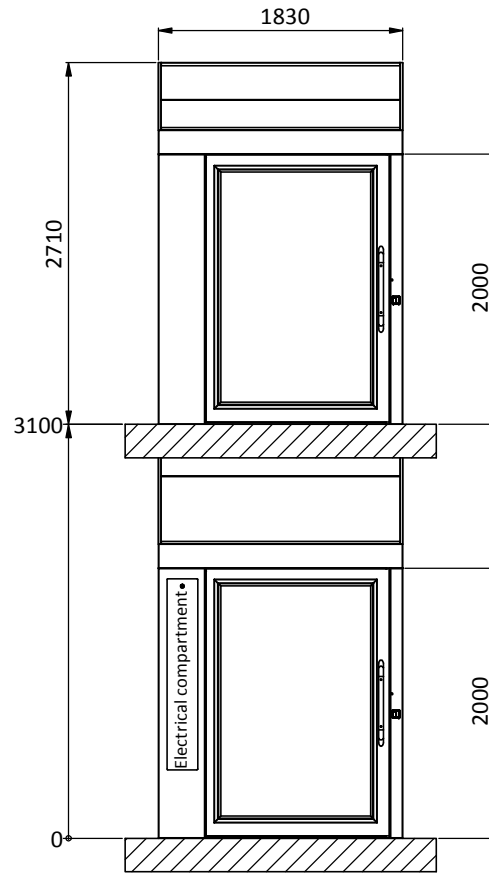

Side A

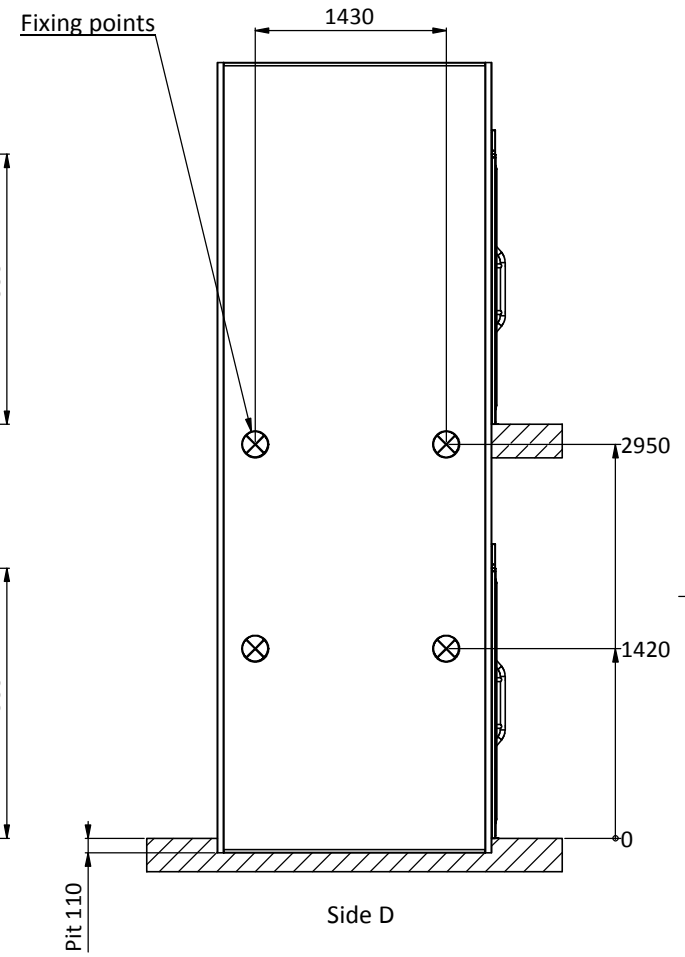

Side D

	Product	Drawn	Checked	Date	Customer
	ILS 1K	TS	JH	2014-09-05	I.L.S AB
Title 2 stop_se 1400x2000					
Innovation Lift Scandinavia AB Kranvägen 6 693 33 Degerfors					Document Number Principal 10
					-Revision -00

Hook in the building ceiling
for 500 kg, by builder

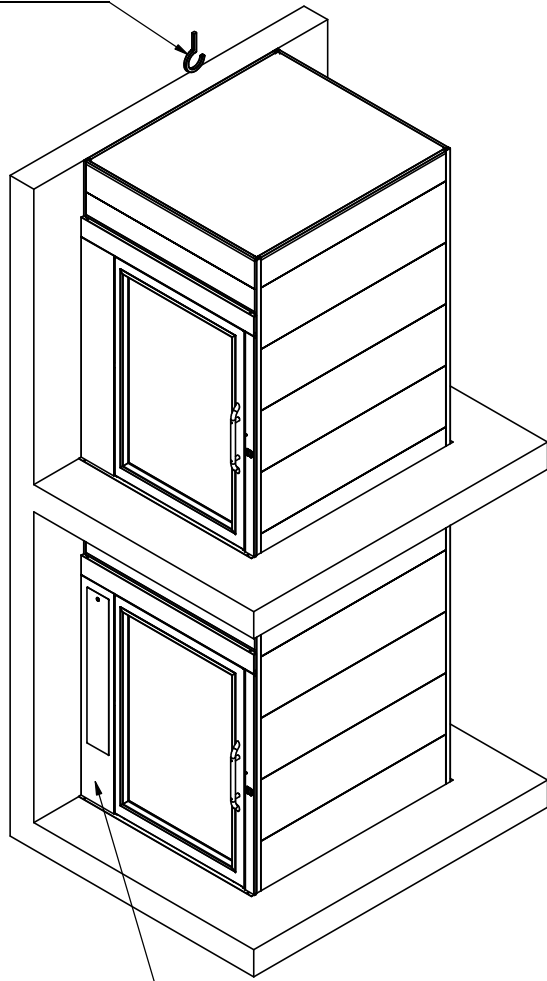

400 V, 3-phase, 16A slow,
Cable Area min 2,5 mm²

400 V, 3-phase, 16A slow,
Cable Area min 2,5 mm²

Overall dimensions

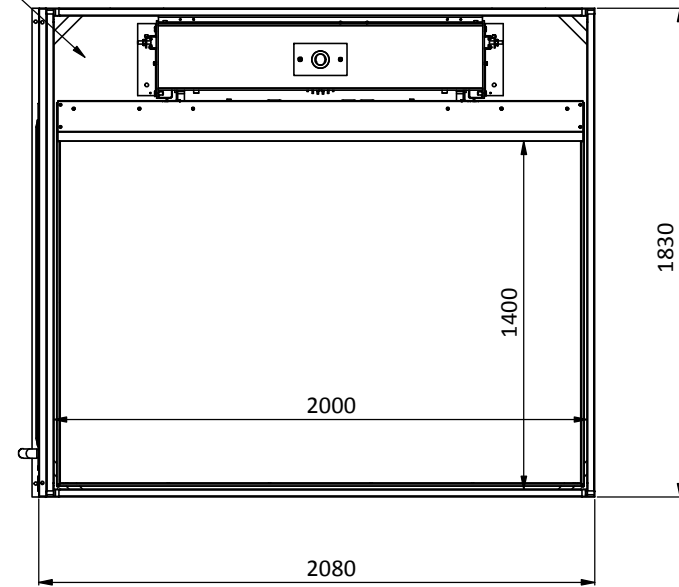

Cut out sizes

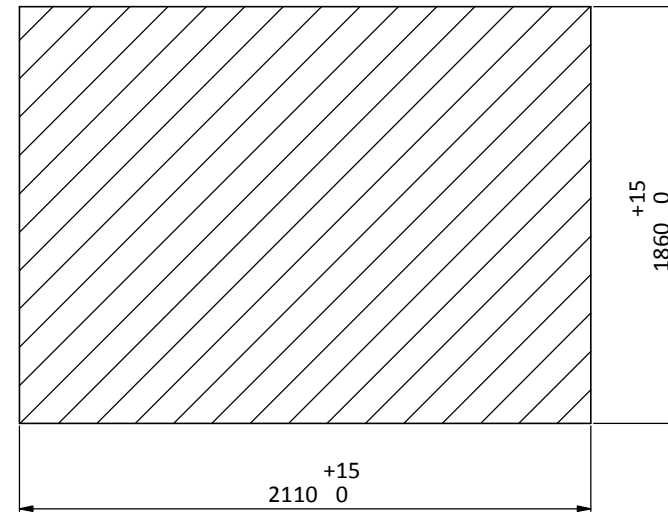

Innovation Lift
SCANDINAVIA AB

Product	Drawn	Checked	Date	Customer
ILS 1K	TS	JH	2014-09-05	I.L.S AB
Title				
2 stop se 1400x2000				
Innovation Lift Scandinavia AB				Document Number
Kranvägen 6				Principal 10
693 33 Degerfors				-Revision
				-00